

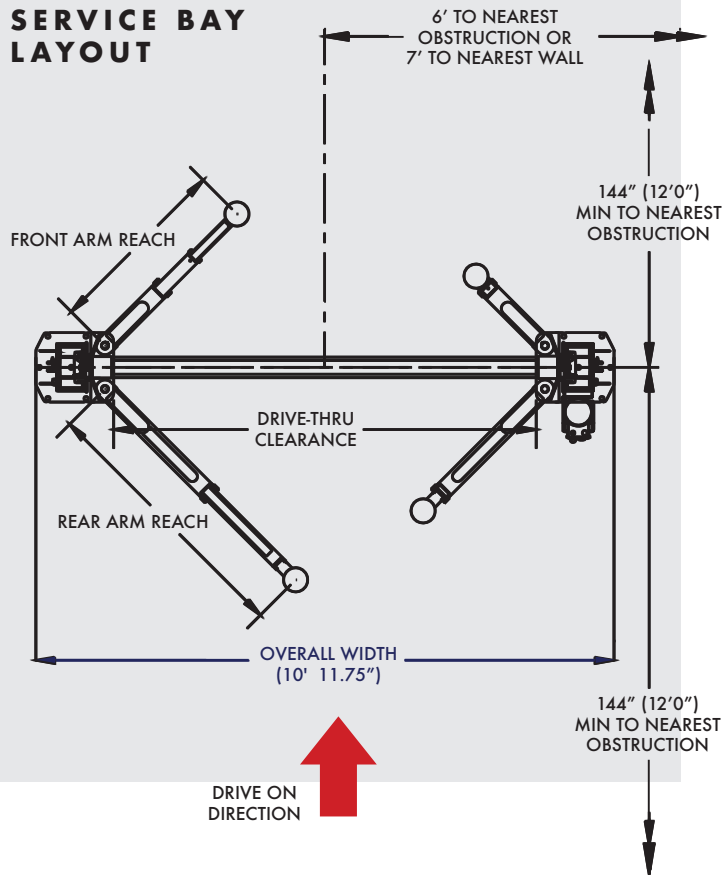

SERVICE BAY LAYOUT



SA10



SITE SPECIFICATIONS

- **BAY HEIGHT:** 12' minimum
- **BAY WIDTH:** 12' recommended
- **BAY DEPTH:** 24' recommended
- **POWER REQ.:** 208-230v Single Phase*, 20-amp breaker
- **MIN. CONCRETE SPEC:** 4" thick, reinforced, free from cracks/seams, rated at 3500+ psi, cured at least 28 days

Model Number	SA10	
Lifting Capacity	10,000 lbs.	
Lifting Configuration	Symmetric	Asymmetric
Arms	3-stage front/2-stage rear	
Rise Height	74.5"	
Overall Height	136.5" / 142.5"	
Overall Height (Cylinder Extended)	142.5"	
Overall Width	129" / 135"	131.5" / 137.5"
Drive-Thru Clearance	92.75" / 98.75"	88.5" / 94.5"
Floor to Overhead Switch	131.125" / 137.125"	
Front Arm Reach	22.375" / 41.5"	
Rear Arm Reach	38.25" / 59"	
Screw Pad Height	4.75" / 6.875"	
Inside Columns	106.75" / 112.75"	101.5" / 107.5"
Motor / Voltage	2HP, 208v-230v, 60Hz, 1Ph	
Speed of Rise	43 s	
Ceiling Height Required	12'	
ALI/ETL Certified	√	
2' Height Extension Available	√	
To Front Obstruction	12'	10'
To Rear Obstruction	12'	14'
Colors Available		

*3-phase upgrade is available for purchase

www.challengerlifts.com
1-800-648-5438